

(1:2)

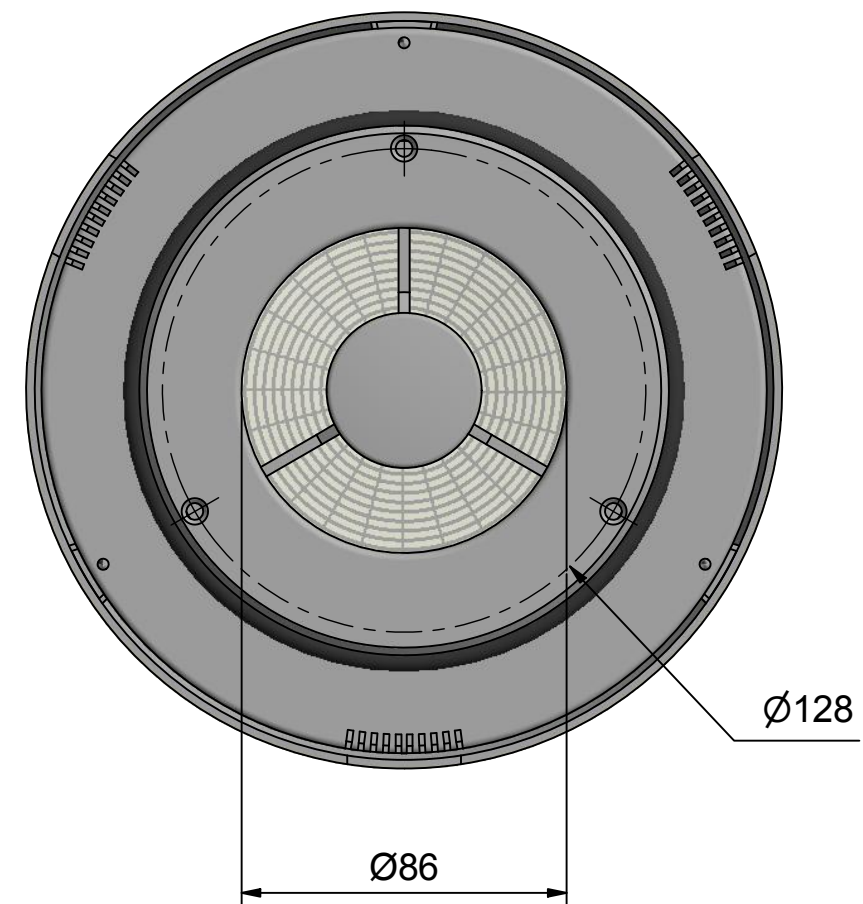
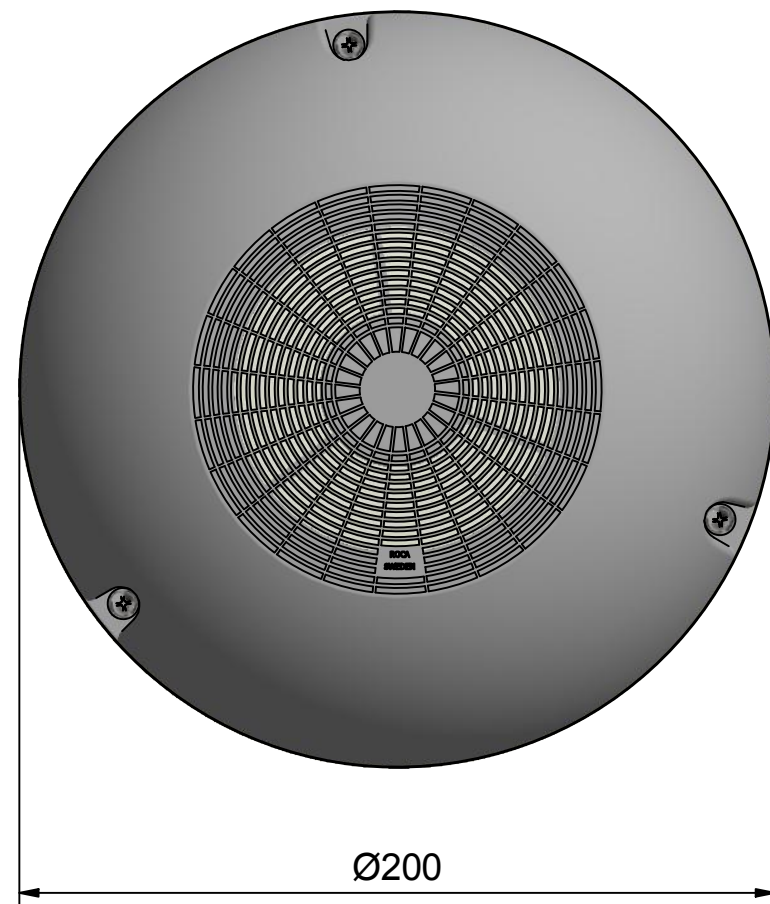

Open area: 5032 mm²